

Diesel Particulate Filters



MINE-X SOOTFILTER®

CONSTRUCTION EARTHMOVING TUNNELING MINING INDUSTRIAL

MINE-X[®]

FOR A CLEANER RUNNING DIESEL ENGINE

DCL diesel particulate filters (brand name: MINE-X SOOTFILTER[®]) effectively reduce particulate matter and smoke from diesel engine exhaust. DCL diesel particulate filters are used to meet MSHA standards for particulate matter in underground mines, EPA or CARB standards for particulate reduction in diesel vehicle retrofits or simply to improve air quality around diesel engines. A vehicle or engine fitted with a DCL diesel particulate filter operates normally, using only the heat in the exhaust gas to continuously burn off particulates.

With thousands of installations worldwide, DCL diesel particulate filters are the industry standard for long, reliable operation. Product approvals include VERT, Japan MLIT, and Sweden Environmental Zones.

DCL diesel particulate filters work best in Tier 1 or higher diesel engines, such as construction, earthmoving and mining vehicles, stationary engines, and post 1994 on-road trucks and buses. Contact DCL or a qualified representative to determine the suitability of a MINE-X SOOTFILTER[®] for other applications.



1 Custom Engineered Designs

In addition to off-the-shelf designs, DCL specializes in custom filter designs that replace original mufflers and unique designs for tightly-spaced exhaust systems.



2 Custom Connections

Virtually any type of connection is available, including pipe, tube and ANSI or DIN flanges.



3 Quick-Release Clamps

With the use of quick-release clamps and a modular design concept, DCL filters can be easily cleaned and serviced.



4 Heavy Gauge Stainless Steel

DCL hardware is specifically designed for the most extreme duty applications.





How IT WORKS

The catalytically-coated ceramic monolith contains long narrow channels open at one end and blocked at the other. The exhaust gas is forced to escape by passing through the filter walls, trapping particulate matter (soot) in the filter. At a high exhaust gas temperature, the soot particles burn away and transform into harmless carbon dioxide. The filter also destroys carbon monoxide (CO) and diesel hydrocarbons (HC).

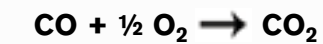
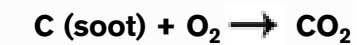
BASIC REACTIONS



Filter Options

	Conversion Efficiency (PM by particle count*)	Conversion Efficiency (PM by mass)	Conversion Efficiency (CO)	Conversion Efficiency (HC)	Effects on NO _x	Typical Balance Point Temperature	Sulphur in Fuel	Typical Backpressure
MINE-X SOOTFILTER[®] LT Effective control of soot, carbon monoxide and hydrocarbons for most mobile and stationary engine applications. 	>99%	70-95%	90%	80%	NO ₂ /NO ratio may increase	300-360 °C	< 50 ppm required	7.5 kPa (clean) 20 kPa (full)
MINE-X SOOTFILTER[®] BM Effective control of soot for heavy-duty vehicles operating in underground mines or in confined spaces where a minimal level of nitrogen dioxide is important. 	>99%	70-95%	-	-	No change in the NO ₂ /NO ratio	380-420 °C	No restrictions	5 kPa (clean) 20 kPa (full)

* ultra-fine and fine particles (diameter 10 – 500 nm)

Installation

A SIMPLE RETROFIT DESIGN FOR EASY INSTALLATION

MINE-X SOOTFILTER®,
California, USA.

How TO INSTALL

- 1** Install filter in a horizontal flow orientation where possible.
- 2** For designs containing quick-release clamps, support the filter-center body.
- 3** For the backpressure alarm, install a 1/4" NPT port upstream of the filter at the 12 o'clock position.
- 4** If necessary, use a flex to isolate the filter from vibrations from the engine or exhaust system.
- 5** Use support brackets to mount the filter to the vehicle frame.
- 6** Use vibration-damping washers if mounting filter on a vehicle frame.
- 7** Use test ports (2 per side) for quick back-pressure or emissions measurements.
- 8** Connect to the engine exhaust using a tube clamp or alternatively by welding or flanges.

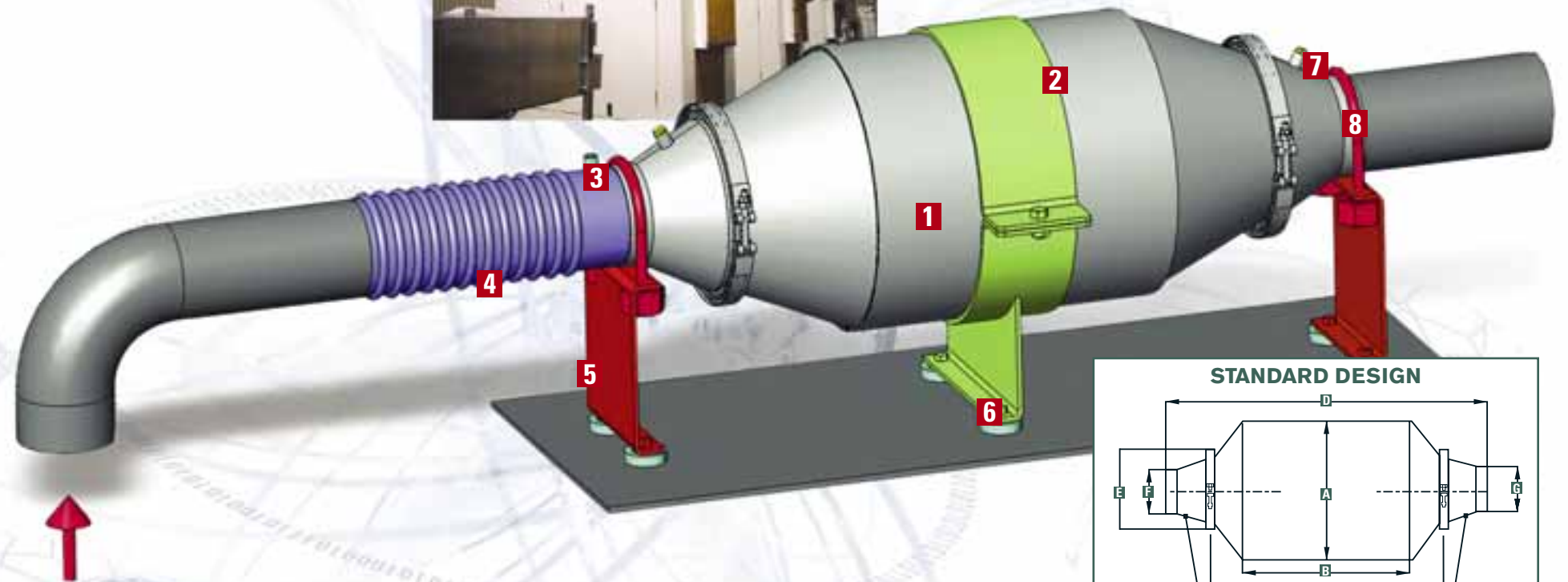

Standard Dimensions

MODEL NUMBER	DCF 1	DCF 2	DCF 3	DCF 4	DCF 5	DCF 6	DCF 7
Max. Engine Power hp (kW)	45 (34)	98 (74)	165 (124)	226 (170)	276 (207)	494 (371)	845 (634)
Max. Exhaust Gas Flow cfm (m³/h) at 400°C	248 (422)	540 (917)	910 (1546)	1246 (2118)	1522 (2586)	2733 (4627)	4659 (7916)
Approximate Weight lb (kg)	11.7 (5.3)	13 (5.9)	29 (13.1)	40 (18.1)	47 (21.3)	78 (35.4)	140 (63.5)
A – filter diameter in (mm)	6.09 (154)	7.93 (201)	9.43 (239)	10.93 (277)	11.68 (297)	15.43 (392)	20.43 (518)
B – filter length in (mm)	6.75 (171)	8.75 (222)	12.75 (324)	12.75 (324)	14.75 (375)	15.75 (400)	15.75 (400)
C – length clamp-clamp in (mm)	7.00 (177)	11.43 (290)	23.00 (584)	23.00 (584)	25.00 (635)	21.63 (549)	24.80 (630)
D – overall length in (mm)	13.75 (349)	19.68 (500)	31.31 (795)	31.31 (795)	33.31 (846)	29.94 (760)	33.11 (841)
E – clamp diameter in (mm)	7.25 (184)	8.25 (210)	8.25 (210)	8.25 (210)	8.25 (210)	8.93 (227)	8.93 (227)
F – outlet diameter in (mm)	CUSTOMER SPECIFIED						
G – inlet diameter in (mm)							

OTHER CONSIDERATIONS

- Filter requires high exhaust temperatures to work properly and therefore should be located as close as possible to the turbo outlet or exhaust manifold of the engine.
- Install filter upstream of the muffler or replace the existing muffler with filter. (The sound attenuation property of filter is similar to an industrial grade muffler).
- Mount filter according to flow direction arrow on the filter housing.
- Mount filter so that it is isolated from external loads.
- Ensure filter does not support weight of exhaust pipe or any other exhaust component.
- Insulate filter if mounting it inside engine compartment or any location with nearby machinery that could be damaged by heat.

Operation + Maintenance

GETTING MORE OUT OF YOUR EMISSIONS CONTROL INVESTMENT

How TO OPERATE



Mobile Equipment

In most respects the equipment can be driven and operated in the normal manner with a MINE-X SOOTFILTER® diesel particulate filter installed.

- Avoid idling the vehicle
- Where possible, use the vehicle for jobs involving heavy engine load; avoid long usages of the vehicle for light duty activities
- Keep the engine well maintained
- Use ultra-low sulphur diesel fuel



Stationary Equipment

In most respects the equipment can be used in the normal manner with the MINE-X SOOTFILTER® diesel particulate filter installed.

- Operate at > 60% load for a minimum of 20% of the time
- Do not operate the engine at idle or low load for longer than 8 continuous hours
- Keep the engine well maintained
- Use ultra-low sulphur diesel fuel



With proper installation and maintenance MINE-X SOOTFILTER® diesel particulate filter last for years in the most extreme duty environments.

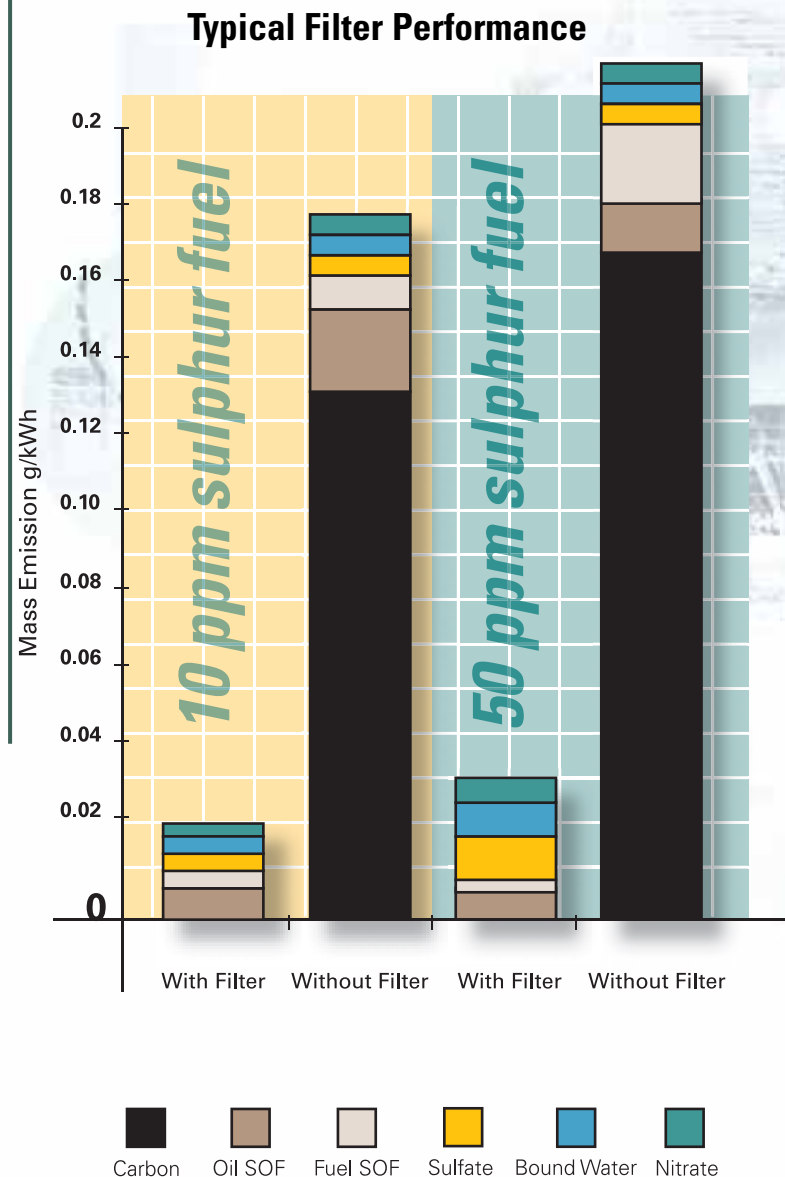

Backpressure Monitor

MINE-X SOOTFILTER® diesel particulate filters are supplied with a backpressure monitor. Mounted in the operator's cabin, the alarm device visually warns the operator of excessive build-up of ash or soot before the problem becomes serious.



A **yellow alarm** light indicates the filter is close to reaching maximum capacity of soot or ash. It is recommended that work activity involving a high engine load (high torque with medium to high rpm) for a continuous period of 20 minutes is conducted to regenerate the filter.

A **red alarm** light indicates that the filter has reached its maximum capacity for soot and ash. Refer to the filter maintenance section or contact DCL for technical support.

How TO MAINTAIN

ACTION	FREQUENCY	DESCRIPTION
Manual Check of Back-Pressure	Every 50 hours of operation	Run engine at high idle and check back-pressure with manual pressure gauge or manometer. Record results on a log sheet. 10" wc (2.5 kPa) ~ clean filter 25" wc (6.2 kPa) ~ moderately loaded filter 40" wc (10 kPa) ~ fully loaded filter (remove for cleaning)
Check for Leaks	Every 200 hours of operation	Make visual check of piping, fittings, clamps and gaskets in the exhaust system for exhaust leaks such as evidence of soot. Repair if necessary.
Check Pressure Transmitter	Every 200 hours of operation	Remove pressure transmitter and apply pressure to the line to check function of transmitter. Check line for leaks. Indicator lights must illuminate at the high pressure setpoints.
Filter Cleaning (Lightly sooted)	Every 1000 hours of operation	Ash build-up on the filter is removed by cleaning the filter with vacuum or low-pressure compressed air. To return the filter for cleaning or for further details, contact DCL technical support.
Filter Cleaning (Heavily sooted)	Every 1000 hours of operation	Ash and soot build-up is removed by heating the filter in an oven for 4 hours at 500 °C. After oven treatment any remaining loose material is removed by cleaning the filter with a vacuum. To return the filter to a qualified filter cleaning site or for further details, contact DCL technical support.

DCL International – Preserving and Improving the Quality of the Air We Breathe

DCL International Inc. is a global leader in the engineering, manufacturing and supporting of advanced emissions control technology for stationary and mobile industrial engines. Our products – which include oxidation and three-way catalysts, silencers, particulate filters, SCR systems and accessories – are used worldwide in the material handling, construction, mining, gas compression and power generation markets.

DCL's dedicated industrial focus is unique in the emissions control industry. To meet the specialized needs of the industrial market, we adopt an integrated approach, bringing together product development, design, manufacturing and testing all under one roof. This single-source capability enables us to provide better engineered emissions solutions that deliver outstanding performance, longer life and lower cost of ownership. Our superior product quality has made DCL the choice of customers around the world.

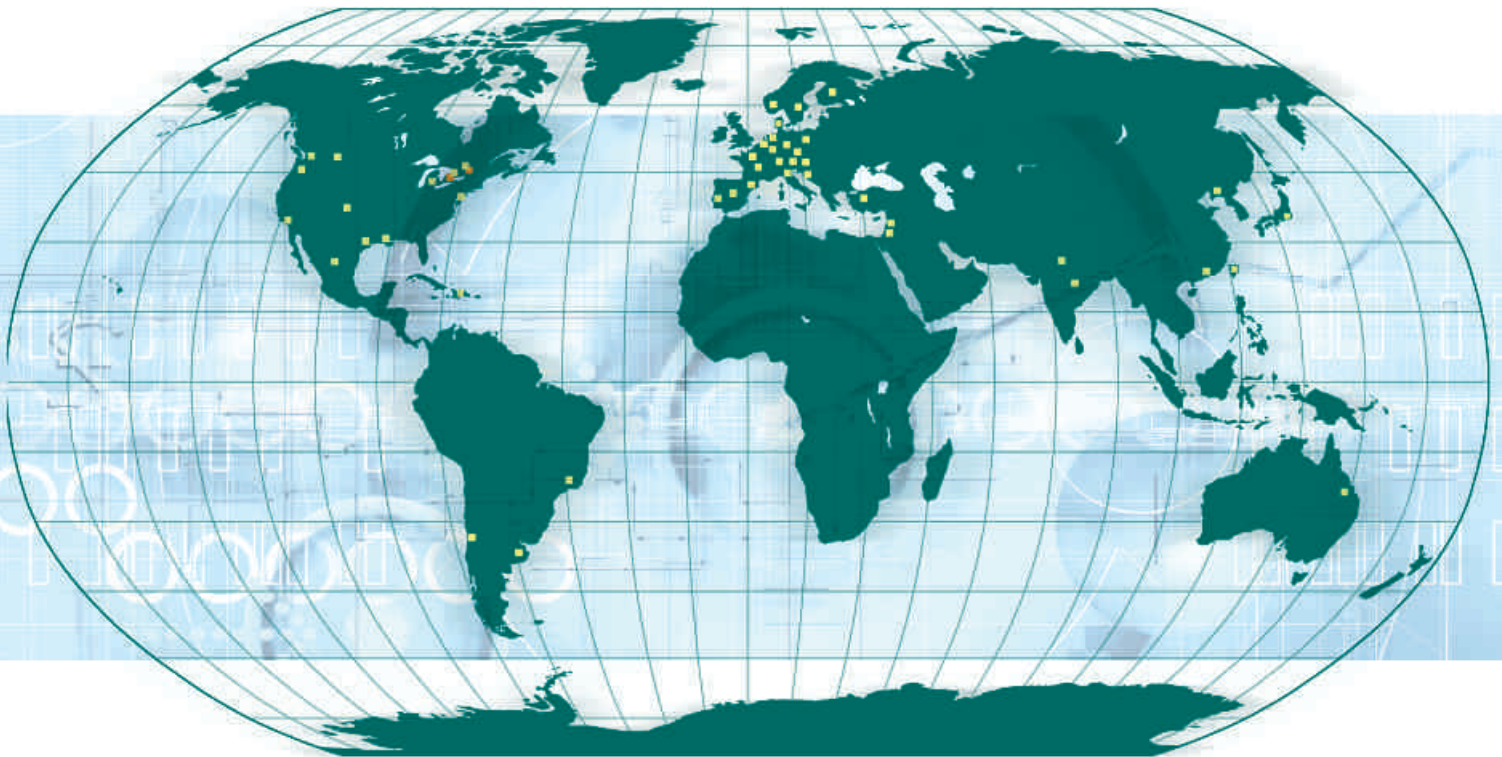

■ Manufacturing Facilities

■ Representatives



DCL International Inc.
Corporate Headquarters
P.O. Box 90
Concord, Ontario
L4K 1B2, Canada
1-800-872-1968

Phone: (905) 660-6450
Fax: (905) 660-6435
e-mail: info@dcl-inc.com
web: www.dcl-inc.com

ISO 9001:2000 Registered